

Ultracell®

'Quality in Every Language'

UXL9-12
12V 9Ah
Long Life Series

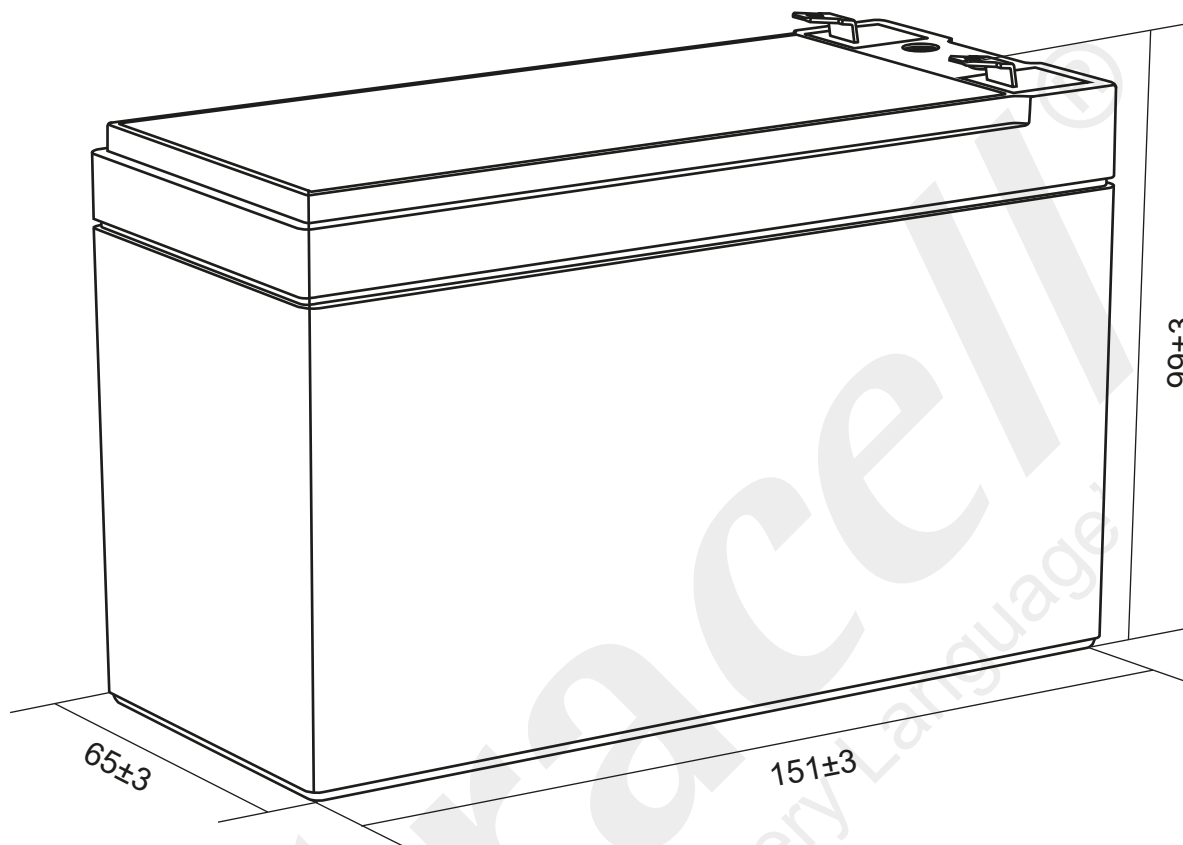

Technical Dimensions (mm)

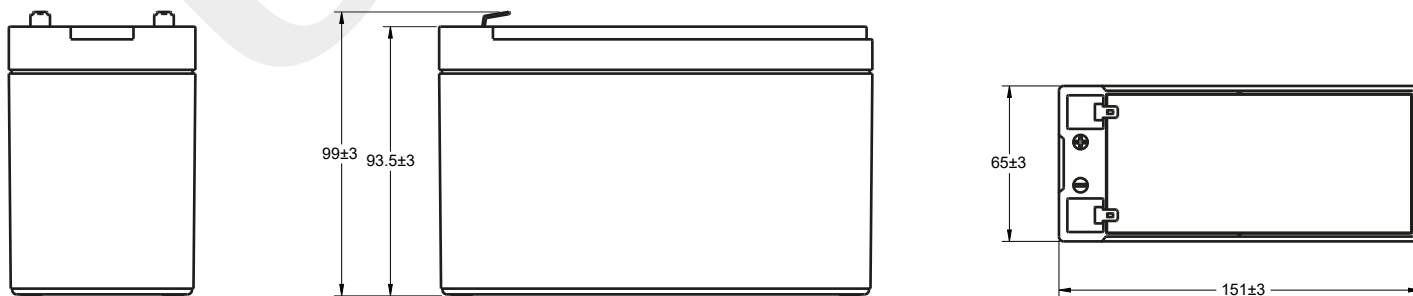



Image



Terminal Dimensions (mm)

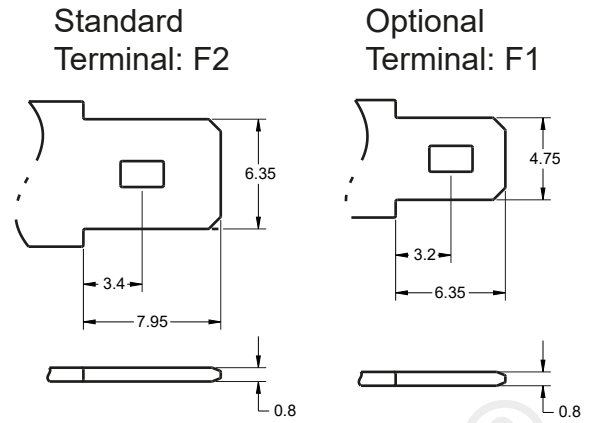

Technical Specification

Output	Nominal Voltage	12V
	Nominal Capacity (20HR)	9Ah
Terminal Type	Standard Terminal	F2
	Optional Terminal	F1
Container Material	Standard Option	ABS
	Flame Retardant Option (FR)	ABS (UL94:VO)
Rated Capacity	(20HR 1.75V/cell, 25°C)	9 Ah/0.450A
	(10HR 1.75V/cell, 25°C)	8.51 Ah/0.851A
	(5HR 1.75V/cell, 25°C)	7.75 Ah/1.55A
	(3HR 1.75V/cell, 25°C)	6.90 Ah/2.30A
	(1HR 1.60V/cell, 25°C)	5.98 Ah/5.98A
Max Discharge Current	135A (5s)	
Internal Resistance	Approx 17mΩ	
Discharge Characteristics	Operating Temp Range	Discharge: -15 ~ 50°C Charge: 0 ~ 40°C Storage: -15 ~ 40°C
	Nominal Operating Temp Range	25 ± 3°C
	Cycle Use	Initial Charging Current less than 2.7A. Voltage 14.4V ~ 15V @ 25°C Temp. Coefficient -30mV/°C
	Standby Use	No limit on initial charging current. Voltage 13.5V ~ 13.8V @ 25°C Temp. Coefficient -20mV/°C
	Capacity affected by Temperature	40°C 103% 25°C 100% 0°C 86%
Design Floating Life at 20°C	10-12 Years	

Self Discharge

Ultracell® UXL batteries may be stored for up to 6 months at 25°C and then a refresh charge is required. For higher temperatures the time intervals will be shorter.

Constant Current Discharge / Constant Power Discharge At 25°C (Amperes & Watts/Cell)

A = Amperes W = Watts

F.V/TIME	5 min	10 min	15 min	20 min	30 min	45 min	60 min	90 min	2 hours	3 hours	4 hours	5 hours	6 hours	8 hours	10 hours	20 hours
1.85V/cell	30.2	20.7	16.1	12.9	9.34	6.72	5.41	3.92	3.08	2.22	1.77	1.51	1.29	1.02	0.832	0.440
1.80V/cell	57.1	39.4	30.8	24.8	18.1	13.0	10.5	7.66	6.03	4.37	3.49	2.98	2.55	2.02	1.65	0.880
1.75V/cell	32.4	21.9	16.9	13.4	9.63	6.90	5.54	4.00	3.14	2.26	1.80	1.53	1.31	1.03	0.843	0.445
1.70V/cell	60.8	41.4	32.1	25.7	18.5	13.3	10.8	7.79	6.13	4.43	3.53	3.02	2.59	2.04	1.67	0.890
1.65V/cell	34.2	22.8	17.4	13.8	9.88	7.05	5.66	4.08	3.19	2.30	1.82	1.55	1.33	1.04	0.851	0.450
1.60V/cell	63.3	42.8	33.0	26.2	18.9	13.6	10.9	7.91	6.22	4.49	3.58	3.05	2.62	2.06	1.69	0.900
1.55V/cell	35.8	23.7	18.0	14.2	10.1	7.21	5.76	4.15	3.24	2.33	1.85	1.57	1.34	1.05	0.860	0.454
1.50V/cell	65.7	44.2	33.9	26.9	19.3	13.8	11.1	8.03	6.30	4.55	3.62	3.09	2.64	2.08	1.71	0.907
1.45V/cell	37.0	24.4	18.5	14.5	10.3	7.32	5.85	4.20	3.28	2.35	1.86	1.58	1.35	1.06	0.866	0.457
1.40V/cell	67.4	45.2	34.6	27.4	19.6	14.0	11.2	8.11	6.36	4.59	3.65	3.11	2.67	2.10	1.72	0.914
1.35V/cell	39.3	25.4	19.1	14.9	10.6	7.50	5.98	4.29	3.34	2.40	1.90	1.61	1.37	1.08	0.877	0.462
1.30V/cell	70.1	46.5	35.6	28.0	20.0	14.3	11.4	8.3	6.46	4.66	3.71	3.15	2.70	2.13	1.74	0.924

Discharge Characteristics

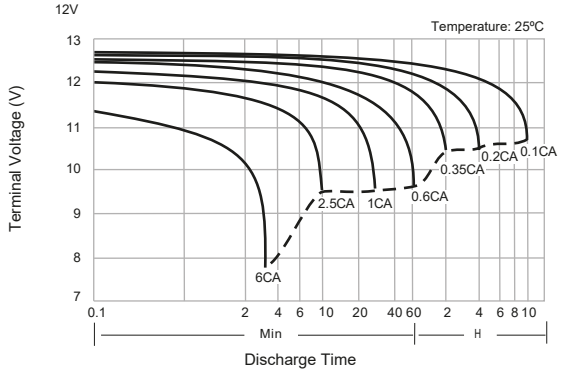

Charging Characteristics

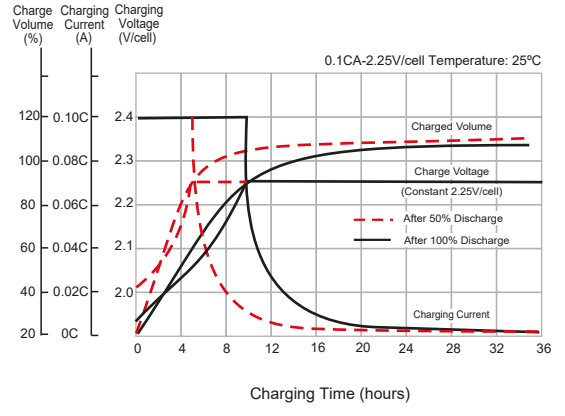

Temperature Effects in Relation to Battery Capacity

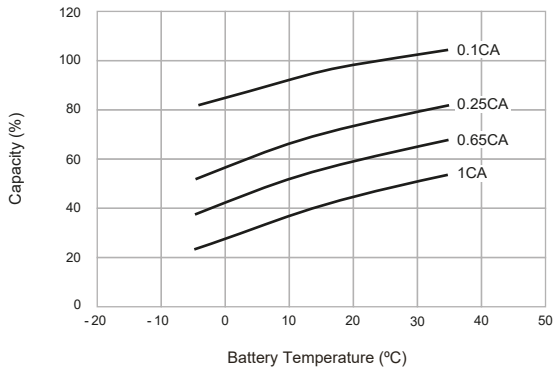

Effect of Temperature on Long Term Float Life

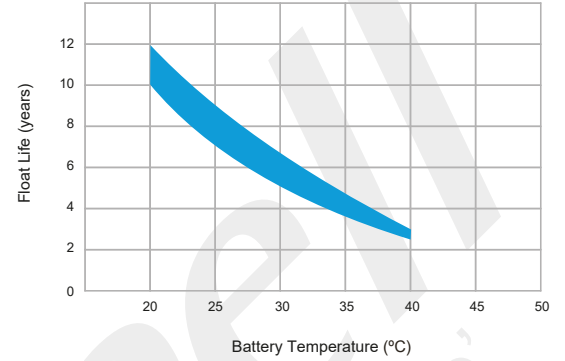

UXL9-12
 12V 9Ah
 Long Life Series

